

Solenoid valves

Manual valves NG6

Manual valve NG6 spool N°3

Page: 1/1

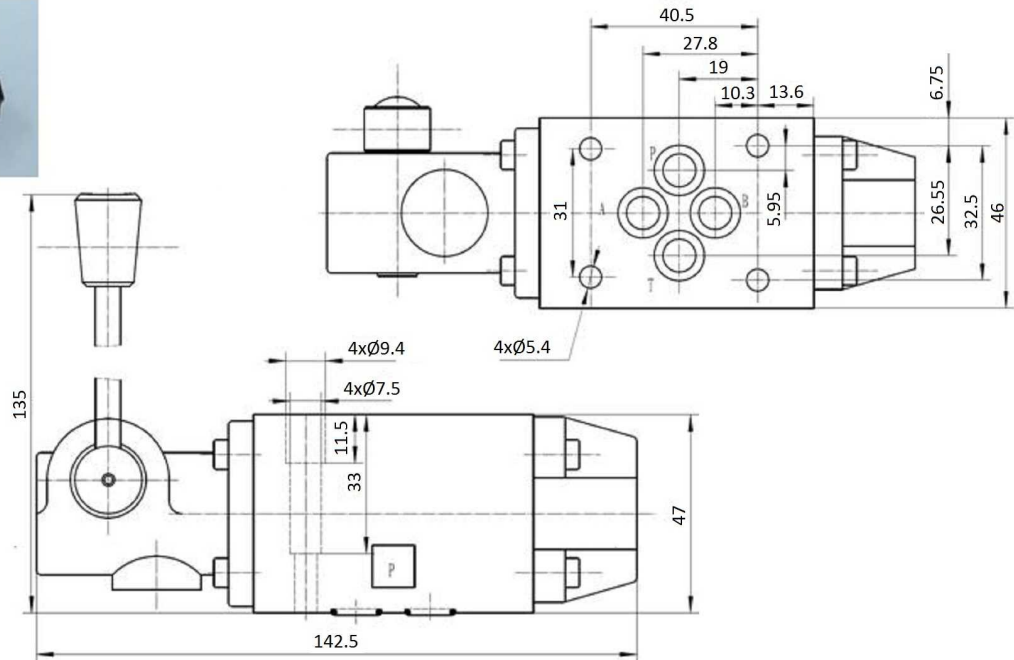
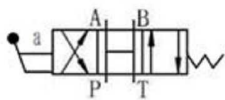

Part n°	Size	Max. flow (l/min)	Max. Press. (bar)
KVNG6M-3 H	NG-6	60	315